

# ASSEMBLY INSTRUCTIONS

# EEI-6019

V1.03.07.22

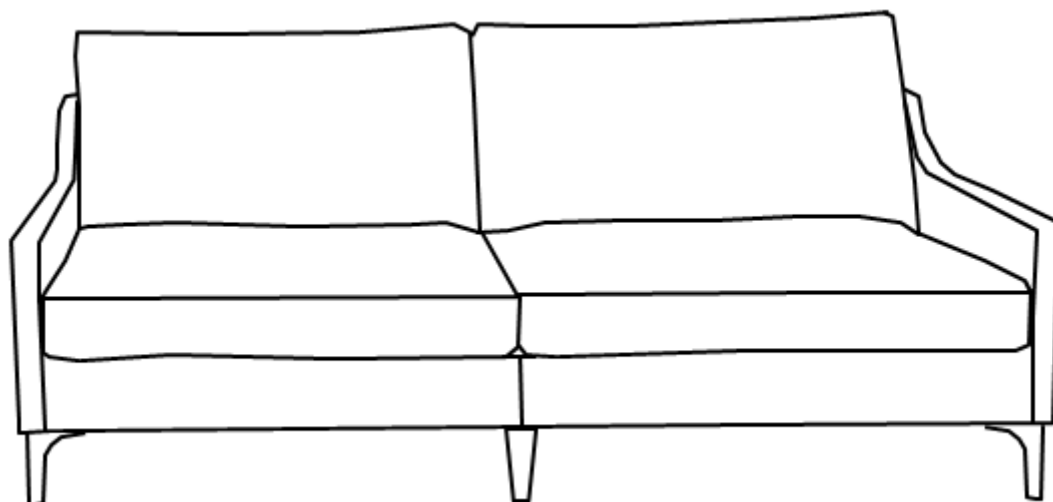

**Questions? Contact us!**

609.256.9000 • [cs@modway.com](mailto:cs@modway.com)  
[www.modway.com](http://www.modway.com)

\*modway

# Let's get started!

\*modway



Read through all of the instructions before starting



Care instructions are listed in the last step of this manual



Approx. 30 minutes assembly time



Make sure you have all parts and components before discarding any packing materials



2 people recommended for assembly

**Only use hand tools to assemble this item.** Do not use power tools. Do not tighten bolts or screws completely until all hardware is lined up and inserted into the holes.

Do not over-tighten screws and bolts to avoid stripping the hardware or cracking the item.

Assemble your item on a flat, carpeted area, with plenty of space to work. This will prevent damage and scratches to your floors or the item while you're assembling the product.

Keep all components and packaging out of reach of children or animals to avoid risk of choking or suffocation.

## Furniture components:

1	Sofa Seat	x1
2	Left Arm	x1
3	Right Arm	x1
4	Sofa Back	x1
5	Back Cushion	x2
6	Metal Leg	x4
7	Middle Leg	x1

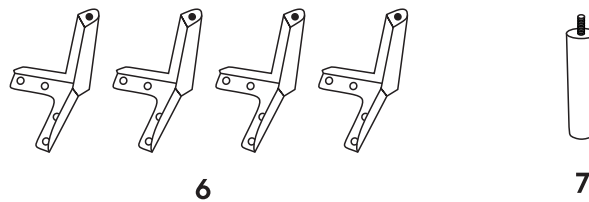
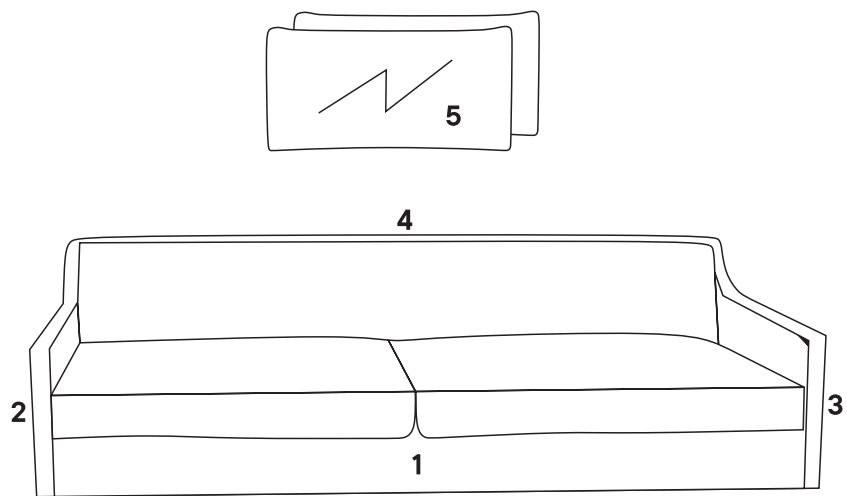

## Provided hardware:

A		Bolt M8 x 60mm	x12
B		Flat Washer M8	x12
C		Allen Wrench M5	x1

Wait!

Missing parts or hardware? Need assistance?  
Contact us before returning your item. We're here to help!  
609.256.9000 • cs@modway.com

# Step 1

## COMPONENTS

- ① Sofa Seat x1
- ② Left Arm x1
- ③ Right Arm x1
- ⑤ Back Cushion x2
- ⑥ Metal Leg x4
- ⑦ Middle Leg x1

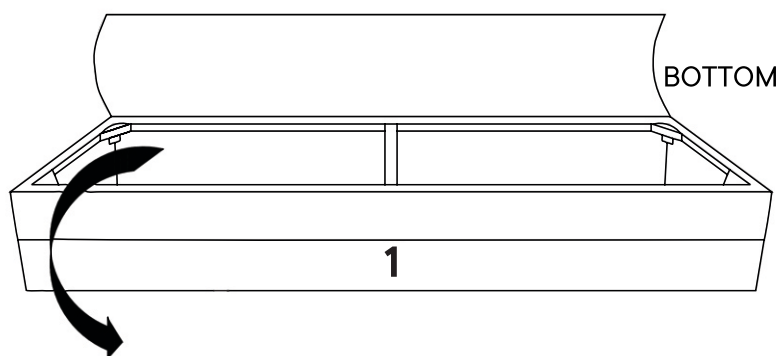

Unzip the bottom cover and locate the Left Arm (2) + Right Arm (3) + 2 Back Cushion (5) + 4 Metal Leg (6) + 1 Middle Led (7) + Hardware package.

# Step 2

## COMPONENTS

- ① Sofa Seat x1
- ② Left Arm x1
- ③ Right Arm x1

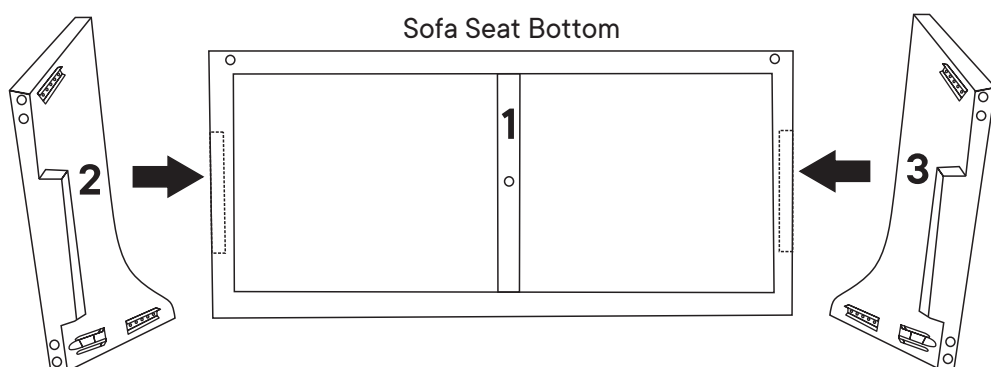
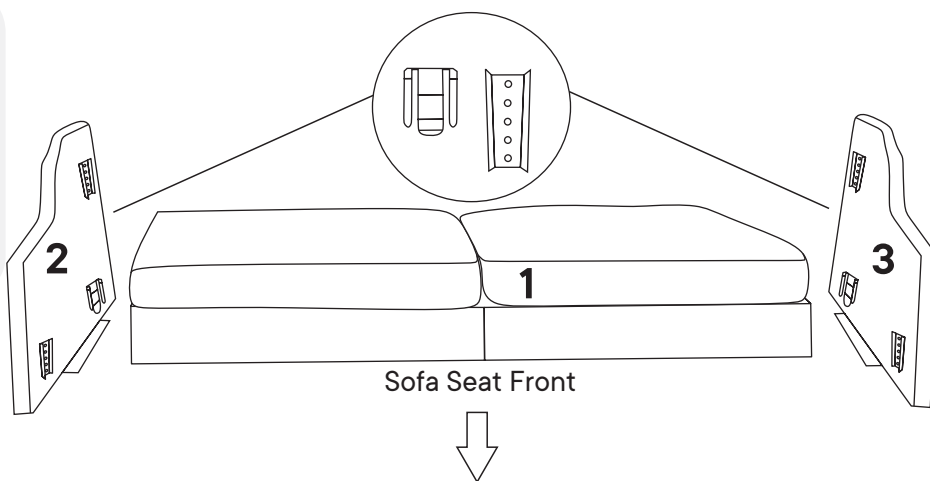

# Step 3

## HARDWARE

<b>A</b>	Bolt M8 x 60mm	x6
<b>B</b>	Flat Washer M8	x6
<b>C</b>	Allen Wrench M5	x1

## COMPONENTS

<b>1</b>	Sofa Seat	x1
<b>2</b>	Left Arm	x1
<b>3</b>	Right Arm	x1
<b>6</b>	Metal Leg	x2

Not require bolt and flat washer.

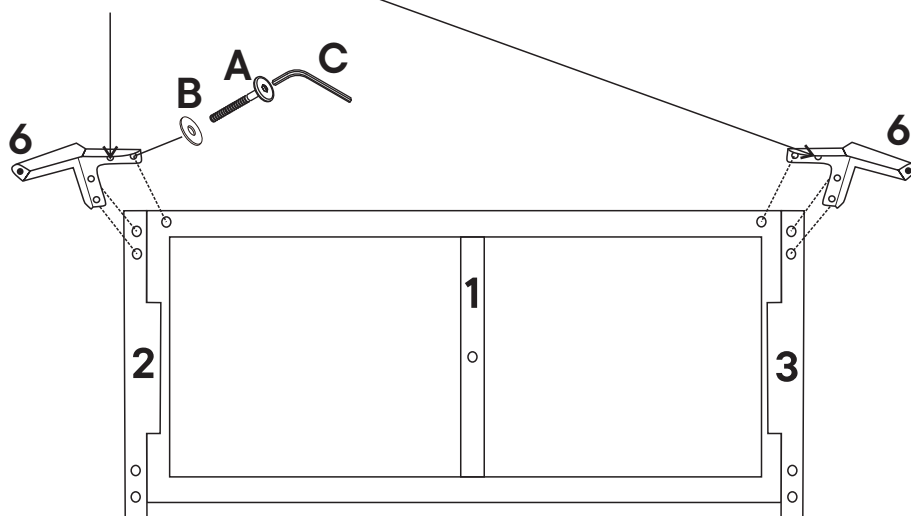

# Step 4

## COMPONENTS

<b>1</b>	Sofa Seat	x1
<b>2</b>	Left Arm	x1
<b>3</b>	Right Arm	x1
<b>4</b>	Sofa Back	x1

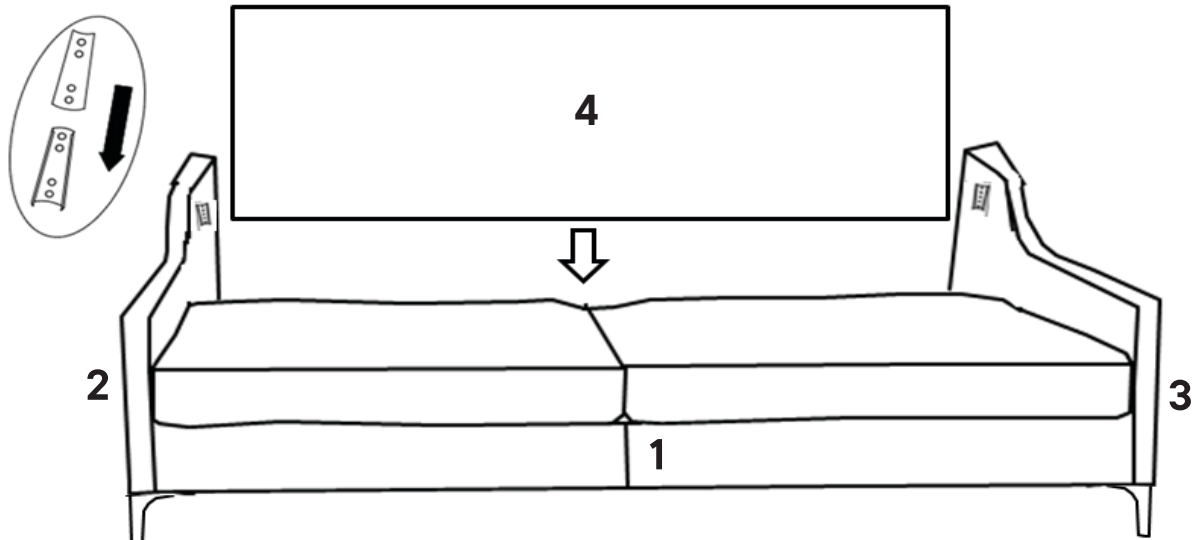

# Step 5

## HARDWARE

- A** Bolt M8 x 60mm x6
- B** Flat Washer M8 x6
- C** Allen Wrench M5 x1

## COMPONENTS

- 1** Sofa Seat x1
- 2** Left Arm x1
- 3** Right Arm x1
- 4** Sofa Back x1
- 6** Metal Leg x2
- 7** Middle Leg x1

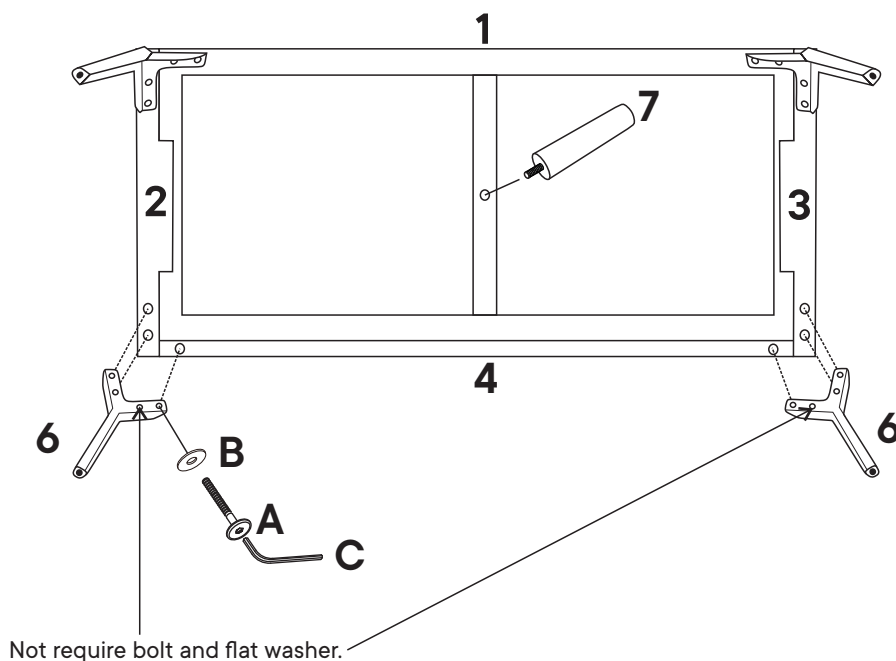

# Step 6

## COMPONENTS

- 5** Back Cushion x2

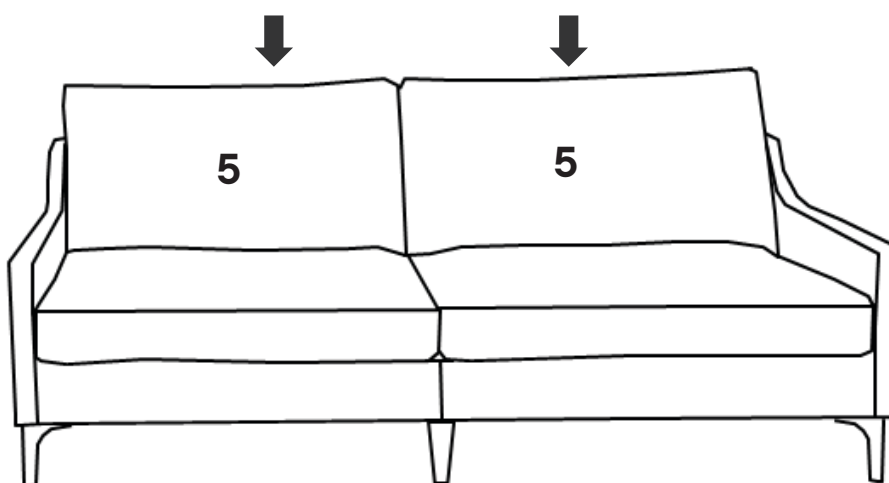

# Great job!

Your Sofa is complete.

## ♥ CARING FOR YOUR ITEM

Indoor use only.

Not contract grade.

Clean using a non-abrasive cloth and a mild cleaner.

Never use harsh chemicals, as they could damage the finish or integrity of the item.

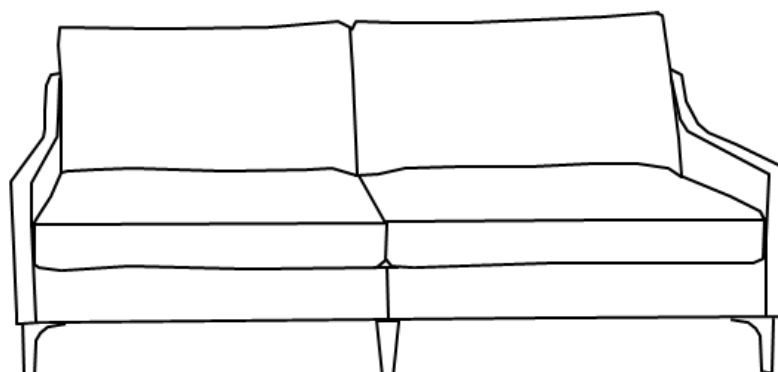

CONNECT WITH US!   

Tag us [@modway\\_furniture](#) and [#modway](#) for a chance to be featured.