



ASSEMBLY INSTRUCTIONS

Read this instruction carefully. See furniture and hardware part lists, on the right, for guidance.

Have all parts ready before assembly. Place all wooden furniture parts on a clean and flat soft surface to prevent from being scratched. Follow the steps below to start assembling.

FURNITURE PART LIST		
ITEM	DESCRIPTION	QTY
A	HEADBOARD	1 PC
B	SUPPORT BOARD	2 PCS

HARDWARE PART LIST		
ITEM	DESCRIPTION	QTY
1	JCBB BOLT M8 x 50mm 	4 PCS
2	M8 FLAT WASHER 	4 PCS
3	M5 ALLEN KEY 	1 PC

- CAUTION :**
1. Do not FULLY - TIGHTEN the nut or bolt until all nuts and bolts are assembled.
 2. Do not OVER - TIGHTEN the nut or bolt to avoid causing damages to the thread.
 3. Keep all hardware parts out of reach of children.

NOTE : THE LIST AND QUANTITY SHOWN ARE FOR 1 UNIT ASSEMBLY.

STEP 1

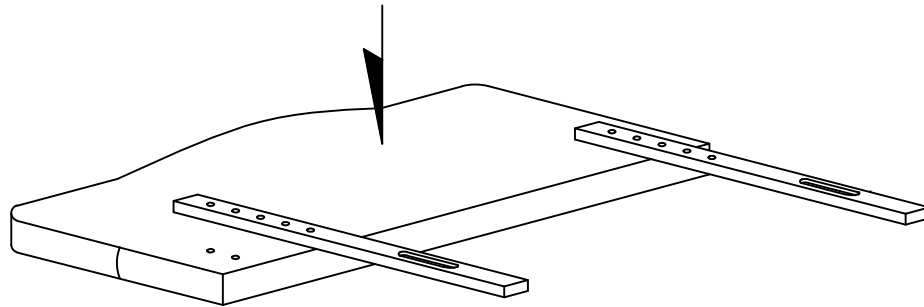

Align support board fixing holes over headboard fixing holes according to your desired height.

STEP 2

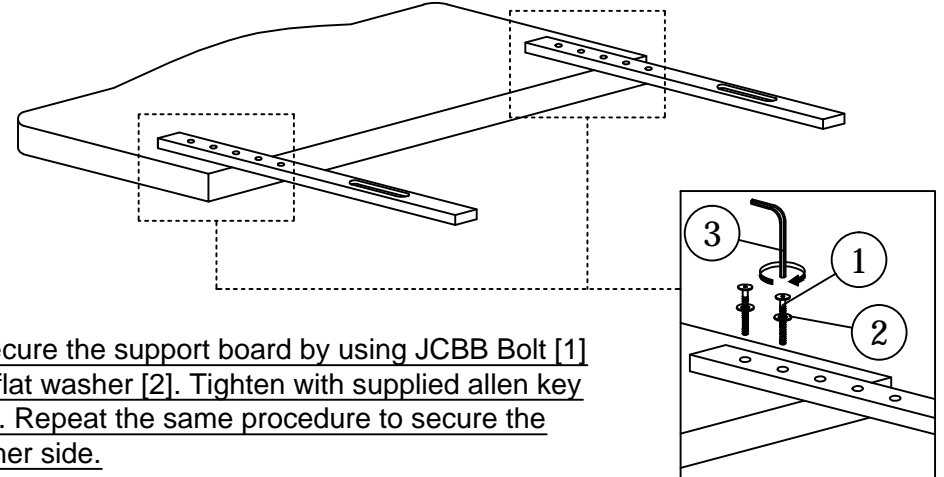

Secure the support board by using JCBB Bolt [1] & flat washer [2]. Tighten with supplied allen key [3]. Repeat the same procedure to secure the other side.

STEP 3

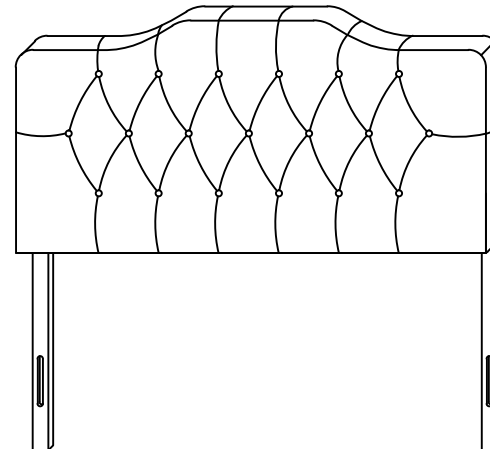

Your headboard assembly is complete.
Note: Hardware may loosen over time. Periodically check that all connections are tight.