

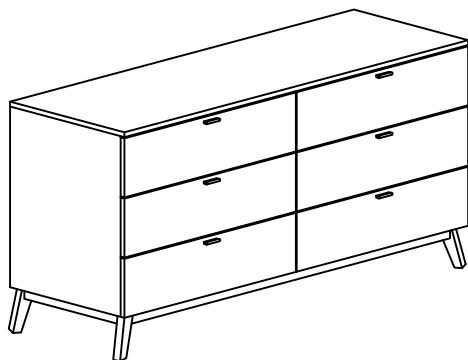









Thank you for purchasing the **MODWAY DRESSER** !
 Before you start, here is some helpful advice:

1. We suggest you spend a short time reading through this leaflet and then follow the simple step by step instructions.
2. Owing to the size and weight of the bed, we recommend that it is assembled by two adults, on a carpeted or padded area, in the room that it is intended for. Approx assembly time: 30 minutes.
3. Please do not use any tools other than those provided or recommended in these instructions.
4. Please do not throw away any of the packaging or the instruction until you have checked all the components and hardware and the furniture is fully assembled. Please ensure that the packaging is disposed of in a safe environmentally friendly way.
5. Assemble all components loosely until advised to tighten. Depending on use, it may be necessary to tighten the components from time to time, so please save the tools that has been provided.
6. Please keep all fitting out of reach of children.

Hardware for DRESSER

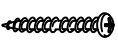

A		JCBC SCREW M6 X 70MM	x8
B		SPRING WASHER 1/4"	x8
C		FLAT WASHER 1/4"	x8
D		M4 ALLEN KEY (BALL SHAPE) LONG	x1
E		HANDLE	x6
F		HANDLE SCREW M4 x 22mm	x12
G		PROTECTION PAD	x4
H		WALL SCREW M4 x 18MM	x1
I		WALL SCREW M4 x 50MM	x1
J		L- BRACKET	x2
K		BELT	x1

Component :

- 1- DRESSER
- 2- LEGS

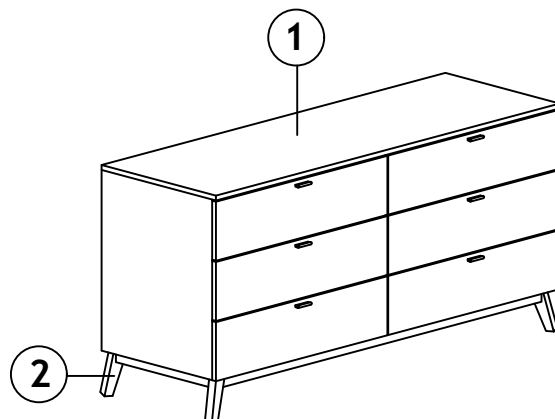



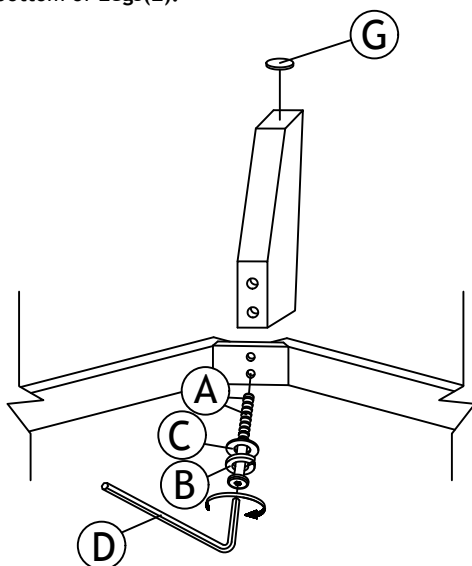

MOD-6194

STEP 1 :

Place DRESSER (1) and Legs (2) on a carpeted or padded area as shown. Attach Legs (2) into DRESSER (1) by inserting JCBC SCREW M6 x 70mm(A), Spring Washer 1/4"(B) and Flat washer 1/4" (C). Tighten with M4 Allen Key (Ball Shape)Long(D). Then, place the PROTECTION PAD(G) on bottom of Legs(2).





				
A x 8	B x 8	C x 8	D x 1	G x 4

Hardware & Tool required

STEP 2 :

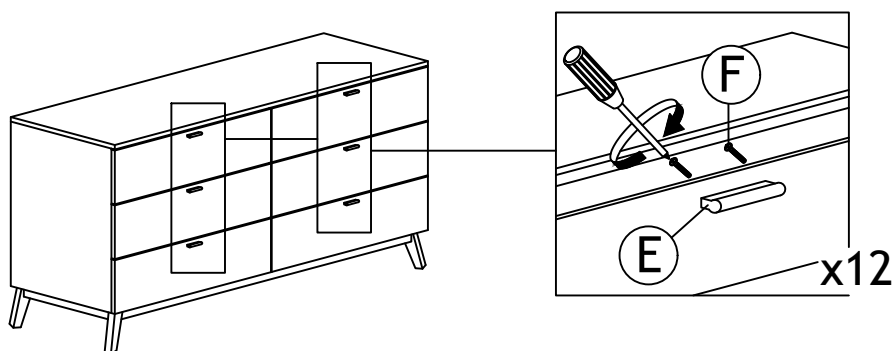
Attach HANDLE (E) with DRESSER (1) together. Then, insert HANDLE SCREW M4 x 22mm (F) through the HANDLE (E). Tighten with Screw Driver.



	
E x 6	F x 12

Hardware & Tool required

STEP 3 :

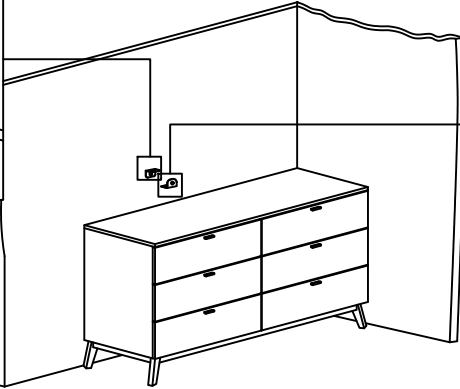
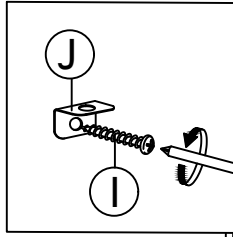

Attach one of the L-Bracket(J) to wall by inserting WALL SCREW M4 x 50MM(I). Then attach another L-Bracket(J) to back side center of Dresser by inserting WALL SCREW M4 x 18MM (H).

STEP 3.1

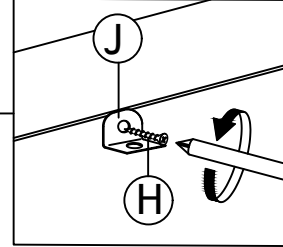

STEP 3.2



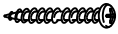

		
J x 2	H x 1	I x 1

Hardware & Tool required

STEP 4 :

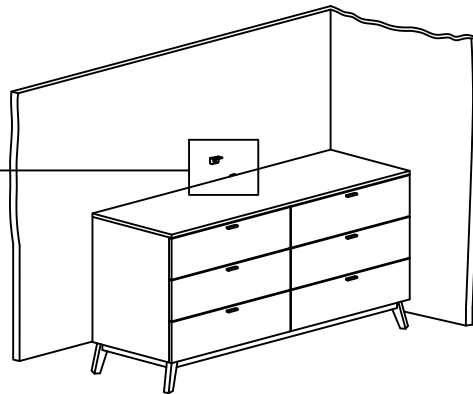
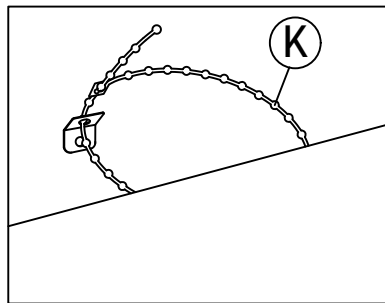
Attach the two L-BRACKET(J) with the BELT(K).



K x 1

Hardware & Tool required

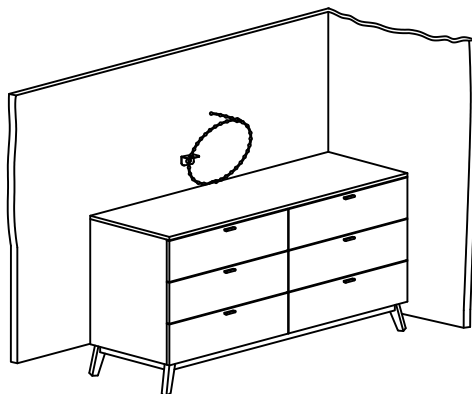

Assembly is complete, the DRESSER is ready to be enjoyed now!