

MOD-6227

Thank you for purchasing the **MODWAY BED!**

Before you start, here are some helpful advice:

1. We suggest you spend a short time reading through this leaflet and then follow the simple step instructions.
2. Owing to the size and weight of the bed, we recommend that it is assembled by two adults, on a carpeted or padded area, in the room that it is intended for. Approx assembly time: 20 minutes.
3. Please do not use any tools other than those provided or recommended in these instructions.
4. Please do not throw away any of the packaging or the instruction until you have checked all the components and hardware and the furniture is fully assembled. Please ensure that the packaging is disposed of in a safe environmentally friendly way.
5. Assemble all components loosely until advised to tighten. Depending on use, it may be necessary to tighten the components from time to time, so please save tools that have been provided.
6. Please keep all fitting out of reach of children.



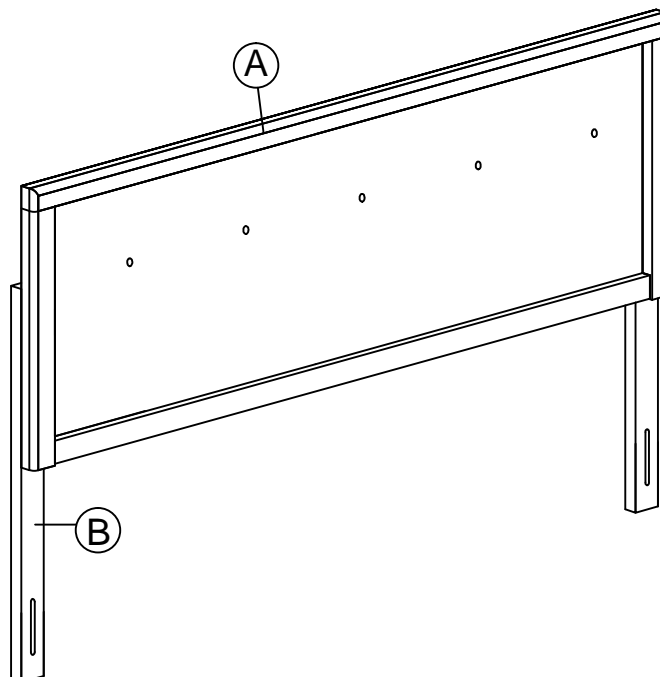

Components:

A	HEADBOARD	1 PC
B	HB SUPPORT	2 PCS
C	BED FRAME (DOES NOT INCLUDE WITH THE PURCHASE)	-



MOD-6227

HARDWARE HEADBOARD

1		JCBC BOLT M6 x 35mm	10 PCS
2		M6 SPRING WASHER	10 PCS
3		M6 FLAT WASHER	10 PCS
4		M4 ALLEN KEY	1 PC

STEP 1

1.1 Align pre-drilled support stand holes over the pre-drilled headboard holes according to your desired headboard height.

1.2 Secure each HB support stand by using 2x JCBC Bolt [1] and 2x M6 Spring Washer [2] and 2x M6 Flat Washer [3]. Tighten with supplied Allen Key [4]. Repeat the same procedure to secure the other side.

Note: Hardware may loosen over time.
Periodically check that all connections are tight.

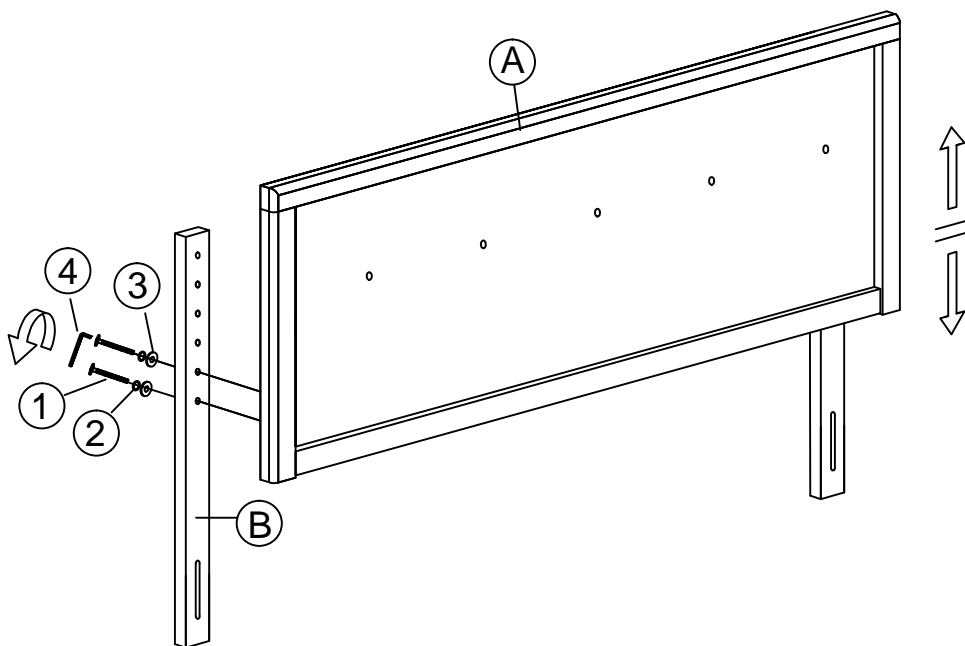

MOD-6227

STEP 2

2.1 Line up the bed frame board's pre-drilled holes to match those of the headboard.

2.2 Secure the headboard to the bed frame by using 3x JCBC Bolt [1] and 3x M6 Spring Washer [2] and 3x M6 Flat Washer [3] for the thicker bed frame. Tighten with supplied Allen Key [4].

2.3 Repeat the same procedure for each screw and each side of the bed frame.

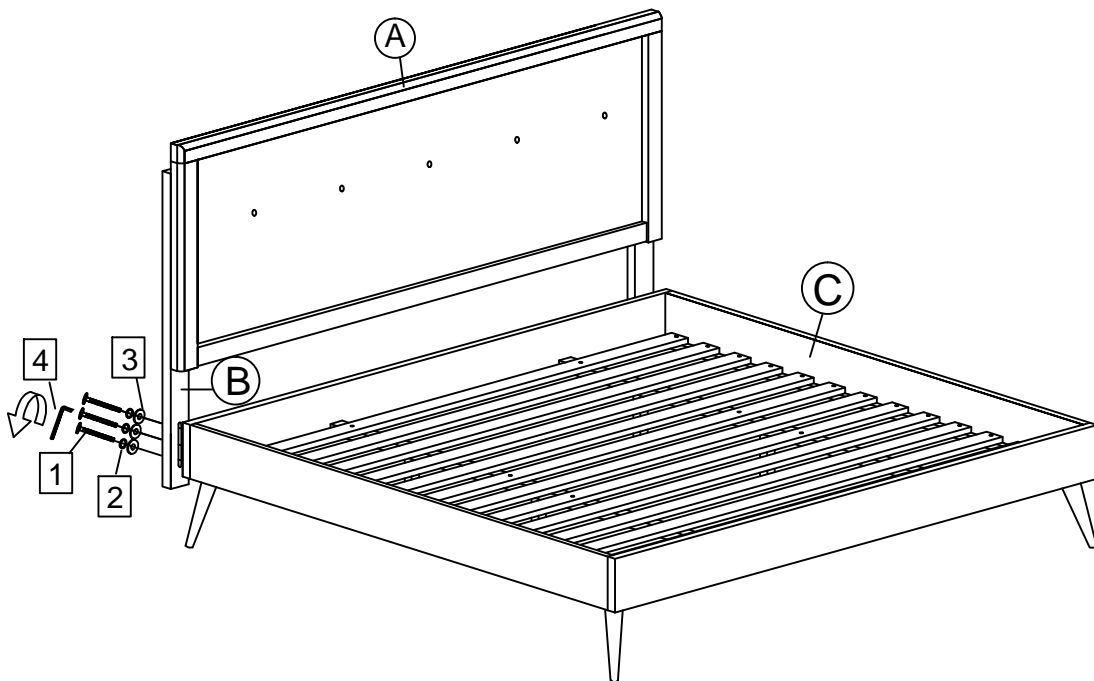

STEP 3

3.1 Assembly completed.

